

Control Modes

- Indexer, Point-to-Point, PVT
- Camming, Gearing, Position, Velocity, Torque

Command Interface

- Stepper commands
Single-ended or Differential selectable
- CANopen
- ASCII and discrete I/O
- $\pm 10V$ position/velocity/torque command
- PWM position/velocity/torque command
- Master encoder (Gearing/Camming)

Communications

- CANopen
- RS232

Feedback

- Digital Quad A/B encoders
- Analog sin/cos encoder (-S option)
- Brushless resolver (-R option)
- Aux encoder / emulated encoder output
- Digital Halls

I/O - Digital

- 12 inputs, 3 outputs

Dimensions: mm [in]

- 168 x 99 x 31 [6.6 x 3.9 x 1.2]



Model	Ip	Ic	Vdc
ADP-055-18	18	6	55
ADP-090-09	9	3	90
ADP-090-18	18	6	90
ADP-090-36	36	12	90
ADP-180-09	9	3	180
ADP-180-18	18	6	180
ADP-180-30	30	15	180

Add -S to part numbers above for sin/cos feedback
Add -R to part numbers above for resolver feedback

DESCRIPTION

Accelnet is a high-performance, DC powered drive for position, velocity (using encoder, resolver, Halls, or BEMF), and torque control of brushless and brush motors. It can operate as a distributed drive using the CANopen, or as a stand-alone drive accepting analog or digital commands from an external motion controller. In stand-alone mode, current and velocity modes accept digital 50% PWM or PWM/polarity inputs as well as $\pm 10V$ analog. In position mode inputs can be incremental position commands from step-motor controllers, analog $\pm 10V$, or A/B quadrature commands from a master-encoder. Pulse to position ratio is programmable for electronic gearing.

Drive commissioning is fast and simple using CME 2™ software operating under Windows® and communicating with *Accelnet* via CAN or an RS-232 link. CAN address selection is by a 16-position rotary switch. If there are more than sixteen devices on the CAN bus, the additional address bits needed can come from programmable inputs, or can be set in flash memory.

Accelnet models operate as Motion Control Devices under the DSP-402 protocol of the CANopen DS-301 V4.01 (EN 50325-4) application layer.

DSP-402 modes supported include: Profile Position, Profile Velocity, Profile Torque, Interpolated Position Mode (PVT), and Homing. The two CAN ports are optically isolated from drive circuits.

Digital quad A/B encoders and Halls are standard feedback devices. Sin/cos analog encoders are supported in models with an "S" appended to the part number. Resolver feedback is supported in models with "R" appended to the part number.

There are twelve digital inputs eleven of which have programmable functions. These include CAN address, motion-abort, limit & home switches, stepper/encoder pulse inputs, reset, digital torque or velocity reference, and motor over-temperature. Input [IN1] is dedicated for the drive Enable. There are three programmable logic outputs for reporting an drive fault, motor brake control, or other status indications.

Drive power is transformer-isolated DC from regulated or unregulated power supplies. An AuxHV input powers control circuits for "keep-alive" operation permitting the drive power stage to be completely powered down without losing position information, or communications with the control system.

GENERAL SPECIFICATIONS

Test conditions: Load = Wye connected load: 2 mH + 2 Ω line-line. Ambient temperature = 25°C, +HV = HV_{max}

MODEL	ADP-055-18	ADP-090-09	ADP-090-18	ADP-090-36	ADP-180-09	ADP-180-18	ADP-180-30	
OUTPUT POWER								
Peak Current	18 (12.7)	9 (6.4)	18 (12.7)	36 (25.5)	9 (6.4)	18 (12.7)	30 (21.2)	Adc (Arms), ±5%
Peak time	1	1	1	1	1	1	1	Sec
Continuous current	6 (4.2)	3 (2.1)	6 (4.2)	12 (8.5)	3 (2.1)	6 (4.2)	15 (10.6)	Adc (Arms) per phase
Peak Output Power	0.92	0.79	1.55	2.95	1.59	3.15	5.2	kW
Continuous " " "	0.32	0.27	0.53	1.06	0.53	1.06	2.6	kW
Output resistance	0.075	0.075	0.075	0.036	0.075	0.075	0.075	Ω
Maximum Output Voltage	Vout = HV*0.97 - Rout*Iout							
INPUT POWER								
HVmin~HVmax	+20 to +55	+20 to +90	+20 to +90	+20 to +90	+20 to +180	+20 to +180	+20 to +180	Vdc, transformer-isolated
Ipeak	20	10	20	40	10	20	33.3	Adc (1 sec) peak
Icont	6.7	3.3	6.7	13.3	3.3	6.7	16.6	Adc continuous
Aux HV	+20 to +HV Vdc @ 500 mAdc maximum							
PWM OUTPUTS								
Type	3-phase MOSFET inverter, 15 kHz center-weighted PWM, space-vector modulation							
PWM ripple frequency	30 kHz							
DIGITAL CONTROL								
Digital Control Loops	Current, velocity, position. 100% digital loop control							
Sampling rate (time)	Current loop: 15 kHz (66.7 μs) Velocity, position loops: 3 kHz (333 μs)							
Commutation	Sinusoidal, field-oriented control for brushless motors							
Modulation	Center-weighted PWM with space-vector modulation							
Bandwidths	Current loop: 2.5 kHz typical, bandwidth will vary with tuning & load inductance							
HV Compensation	Changes in bus voltage do not affect bandwidth							
Minimum load inductance	200 μH line-line							
COMMAND INPUTS								
CANopen communications	Profile Position, Profile Velocity, & Profile Torque, Interpolated Position (PVT), Homing							
Digital position reference	Step/Direction, CW/CCW Stepper commands (2 MHz maximum rate)							
	Quad A/B Encoder 2 M lines/sec, 8 M count/sec (after quadrature)							
Digital position/velocity/torque reference	PWM, Polarity PWM = 0~100%, Polarity = 1/0							
	PWM frequency range PWM = 50% +/-50%, no polarity signal required							
	PWM minimum pulse width 1 kHz minimum, 100 kHz maximum							
Analog torque, velocity, position	±10 Vdc 220 ns Differential, 5 kΩ impedance							
DIGITAL INPUTS								
Number	12							
Inputs [IN1~5]	74HC14 Schmitt trigger, 330 μs (33 μs [IN5]) RC filter, Vin-LO < 1.35 Vdc, Vin-HI > 3.65 Vdc, +30 Vdc max [IN1] dedicated to drive enable function, other inputs are programmable							
Input [IN6]	74HC14 Schmitt trigger, 100 ns RC filter, Vin-LO < 1.35 Vdc, Vin-HI > 3.65 Vdc, +12 Vdc max							
Inputs [IN7~10]	Single-ended: Comparator with 2.5 Vdc reference, 100 ns RC filter, Vin-LO < 2.3 Vdc, Vin-HI > 2.45 Vdc							
	Differential: RS-485 line receiver on input pairs [IN9-7], and [IN10-8], 100 ns RC filters, +12 Vdc max							
All inputs	10 kΩ pull-up to +5 Vdc or pull-down to ground, selectable in groups, active level programmable							
DIGITAL OUTPUTS								
Number	3							
[OUT1], [OUT2], [OUT3]	Current-sinking MOSFET with 1 kΩ pullup to +5 Vdc through diode							
Current rating	1 Adc max, +30 Vdc max. Functions programmable							
	External flyback diode required if driving inductive loads							
MULTI-MODE ENCODER PORT								
Operation	Programmable as input for secondary (dual) digital encoder or as buffered outputs in quad A/B/X format for digital motor feedback encoder, or emulated encoder outputs from analog sin/cos motor feedback encoder (ServoTube) or resolver							
Signals	Quad A/B Encoder: A, /A, B, /B, X, /X							
Frequency	As input for digital encoder: 5M lines/sec, 20 M count/sec (after quadrature)							
	As buffered outputs for digital motor encoder: 5 M lines/sec, 20 M count/sec (after quadrature)							
	As emulated encoder outputs for sin/cos analog motor encoder: 4.5 M lines/sec, 18 M count/sec (after quadrature)							
Input/output	26C32 differential line receiver, or 26C31 differential line driver							
RS-232 PORT								
Signals	RxD, TxD, Gnd in 6-position, 4-contact RJ-11 style modular connector.							
Mode	Full-duplex, serial communication port for drive setup and control, 9,600 to 115,200 Baud							
Protocol	ASCII or Binary format							
Multi-drop	ASCII interface from single RS-232 port to control multiple drives (<i>Xenus</i> , <i>Accelnet</i> , <i>Stepnet</i>)							
	Drive with serial connection acts as master for bi-directional data flow to other drives using CAN connections in daisy-chain from drive to drive							
CAN PORT								
Signals	CANH, CANL, Gnd in dual 8-position RJ-45 style modular connectors, wired as per CAN Cia DR-303-1, V1.1							
	CAN interface circuit and +5 Vdc supply are optically isolated from drive circuits							
Format	CAN V2.0b physical layer for high-speed connections compliant							
Data	CANopen Device Profile DSP-402							
Address selection	16 position rotary switch on front panel with 3 additional address bits available as digital inputs or programmable to flash memory							

FEEDBACK

DIGITAL QUAD A/B ENCODER

Type Quadrature, differential line driver outputs
 Signals A, /A, B, /B, (X, /X, index signals optional)
 Frequency 5 MHz line frequency, 20 MHz quadrature count frequency

ANALOG ENCODER (-S OPTION)

Type Sin/Cos, differential line driver outputs, 1.0 V Vpeak-peak typical, 1.25 Vpeak-peak maximum
 Signals Sin(+), Sin(-), Cos(+), Cos(-), ± 0.25 V, centered about 2.5 Vdc
 Common-mode voltage 0.25 to 3.75 Vdc
 Frequency 230 kHz maximum line (cycle) frequency
 Interpolation 10 bits/cycle (1024 counts/cycle)

RESOLVER (-R OPTION)

Type Brushless, single-speed, 1:1 to 2:1 programmable transformation ratio
 Resolution 14 bits (equivalent to a 4096 line quadrature encoder)
 Reference frequency 7.5 kHz
 Reference voltage 2.8 Vrms, auto-adjustable by the drive to maximize feedback
 Reference maximum current 100 mA
 Maximum RPM 10,000+

ENCODER EMULATION

Resolution Programmable to 16,384 counts/rev (4096 line encoder equivalent)
 Buffered encoder outputs 26C31 differential line driver

DIGITAL HALLS

Type Digital, single-ended, 120° electrical phase difference
 Signals U, V, W
 Frequency Consult factory for speeds >10,000 RPM
 Connection Typically to J2-3,6,9; optionally to J3-10,11,12 when resolver feedback connects to J2

ANALOG HALLS (-S OPTION)

Type HA/HB, differential line driver outputs, 1.0 V Vpeak-peak typical, 1.25 Vpeak-peak maximum
 Signals HA(+), HA(-), HB(+), HB(-), ± 0.25 V, centered about 2.5 Vdc
 Common-mode voltage 0.25 to 3.75 Vdc
 Frequency 230 kHz maximum line (cycle) frequency
 Use Multi-mode port as primary incremental encoder input for position feedback

ENCODER POWER SUPPLY

Power Supply +5 Vdc @ 400 mA to power encoders & Halls
 Protection Current-limited to 750 mA @ 1 Vdc if overloaded
 Encoder +5 Vdc developed from +HV or Aux_HV so feedback is not lost if +HV is removed with Aux_HV powered

MOTOR CONNECTIONS

Phase U, V, W PWM outputs to 3-phase ungrounded Wye or delta connected brushless motors, or DC brush motors
 Hall U, V, W Digital Hall signals, single-ended
 Digital Encoder Quadrature encoder signals, A, /A, B, /B, X, /X), differential (X or Index signal not required)
 5 MHz maximum line frequency (20 M counts/sec)
 26LS32 differential line receiver with 121 Ω terminating resistor between complementary inputs
 Analog Encoder Sin/cos, differential line driver outputs, 0.5 Vpeak-peak (1.0 Vpeak-peak differential)
 centered about 2.5 Vdc typical. Common-mode voltage 0.25 to 3.75 Vdc
 Signals Sin(+), sin(-), cos(+), cos(-)
 Frequency 230 kHz maximum line (cycle) frequency
 Interpolation Programmable: 10 bits/cycle (1024 counts/cycle)
 Resolver R1, R2, S3, S1, S2, S4
 Hall & encoder power +5 Vdc $\pm 2\%$ @ 400 mAdc max, current limited to 750 mAdc @ +1 Vdc if output overloaded
 Motemp [IN5] Motor overtemperature sensor input. Active level programmable
 Programmable to disable drive when motor over-temperature condition occurs
 Same input circuit as GP digital inputs (Digital Inputs above)
 Brake [OUT1,2,3] programmable for motor brake function, external flyback diode required

STATUS INDICATORS

Amp Status Bicolor LED, drive status indicated by color, and blinking or non-blinking condition
 CAN Status Bicolor LED, status of CAN bus indicated by color and blink codes to CAN Indicator Specification 303-3

PROTECTIONS

HV Overvoltage +HV > HV_{max} Drive outputs turn off until +HV < HV_{max} (See Input Power for HV_{max})
 HV Undervoltage +HV < +20 Vdc Drive outputs turn off until +HV > +20 Vdc
 Drive over temperature Heat plate > 70°C. Drive outputs turn off
 Short circuits Output to output, output to ground, internal PWM bridge faults
 I²T Current limiting Programmable: continuous current, peak current, peak time
 Motor over temperature Digital inputs programmable to detect motor temperature switch

MECHANICAL & ENVIRONMENTAL

Size 6.58 in (167 mm) X 3.89 in (98.8 mm) X 1.17 in (29.7 mm)
 Weight 0.94 lb (0.43 kg)
 Ambient temperature 0 to +45°C operating, -40 to +85°C storage
 Humidity 0 to 95%, non-condensing
 Vibration 2 g peak, 10~500 Hz (sine), IEC60068-2-6
 Shock 10 g, 10 ms, half-sine pulse, IEC60068-2-27
 Contaminants Pollution degree 2
 Environment IEC68-2: 1990
 Cooling Heat sink and/or forced air cooling required for continuous power output

Notes: 1. Digital input & output functions are programmable.

COMMUNICATIONS

CME 2 SOFTWARE

Drive setup is fast and easy using CME 2 software communicating via RS-232 or over the CAN bus. All of the operations needed to configure the drive are accessible through this powerful and intuitive program. Auto-phasing of brushless motor Hall sensors and phase wires eliminates "wire and try". Connections are made once and CME 2 does the rest thereafter. Encoder wire swapping to establish the direction of positive motion is eliminated.

Motor data can be saved as .ccm files. Drive data is saved as .ccx files that contain all drive settings plus motor data. This eases system management as files can be cross-referenced to drives. Once a drive configuration has been completed systems can be replicated easily with the same setup and performance. When operating as a stand-alone drive that takes command inputs from an external controller, CME 2 is used for configuration. When operated as a CAN node, CME 2 can be used for programming before and after installation in a CAN network. Accelnet can also be controlled via CME 2 while it is in place as a CAN node. During this process, drive operation as a CAN node is suspended. When adjustments are complete, CME 2 relinquishes control of the drive and returns it to the CAN node state.

RS-232 COMMUNICATION

Accelnet operates as a DTE device from a three-wire, full-duplex RS-232 port at 9,600 to 115,200 Baud. COM port settings must be "N81" (No parity, 8 data-bits, 1 stop-bit). The SER-CK Serial Cable Kit provides an adapter that connects to the COM port of a PC (a 9 position, male D-Sub connector) and accepts a modular cable with RJ-11 connectors for connection to the Accelnet RS-232 port (J6).

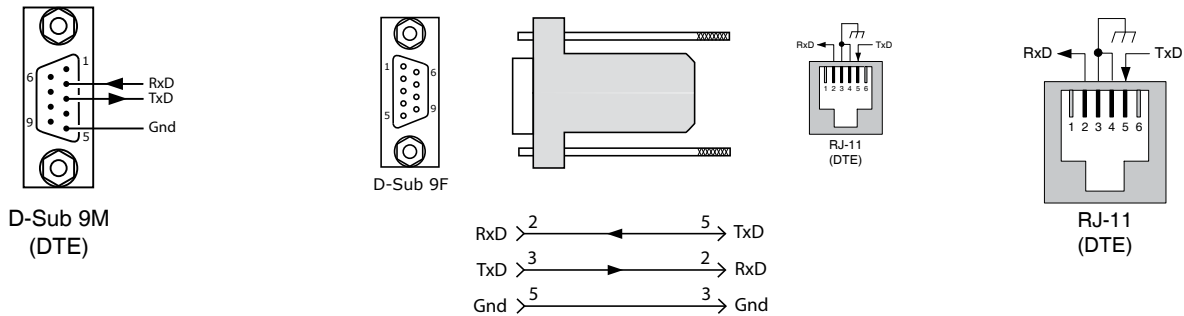

PC COM PORT SIGNALS

SER-CK SERIAL CABLE KIT ADAPTER CONNECTIONS

J5 SIGNALS

RS-232 "MULTI-DROP"

The RS-232 specification makes no allowance for more than two devices on a serial link. But, multiple Accelnet drives can communicate over a single RS-232 port by daisy-chaining a master drive to other drives using CAN cables. In the CAN protocol, address 0 is reserved for the CAN master and thereafter all other nodes on a CAN network must have unique, non-zero addresses. When the Accelnet CAN address is set to 0, it acts as a CAN master, converting the RS-232 data into CAN messages and passing it along to the other drives which act as CAN nodes.

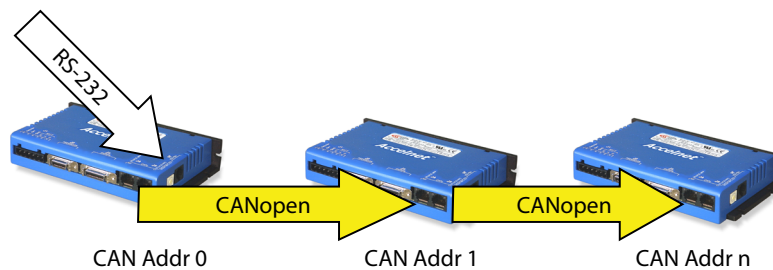

ASCII COMMUNICATIONS

The Copley ASCII Interface is a set of ASCII format commands that can be used to operate and monitor Copley Controls Accelnet, Stepnet, and Xenus series amplifiers over an RS-232 serial connection. For instance, after basic amplifier configuration values have been programmed using CME 2, a control program can use the ASCII Interface to:

- Enable the amplifier in Programmed Position mode.
- Home the axis.
- Issue a series of move commands while monitoring position, velocity, and other run-time variables.

Additional information can be found in the ASCII Programmers Guide on the Copley website: [ASCII Programmers Guide](#)

COMMUNICATIONS (CONTINUED)

CANOPEN

Based on the CAN V2.0b physical layer, a robust, two-wire communication bus originally designed for automotive use where low-cost and noise-immunity are essential, CANopen adds support for motion-control devices and command synchronization. The result is a highly effective combination of data-rate and low cost for multi-axis motion control systems. Device synchronization enables multiple axes to coordinate moves as if they were driven from a single control card.

CANOPEN COMMUNICATION

Accelnet uses the CAN physical layer signals CANH, CANL, and GND for connection, and CANopen protocol for communication. Before installing the drive in a CAN system, it must be assigned a CAN address. A maximum of 127 CAN nodes are allowed on a single CAN bus. The rotary switch on the front panel controls the four lower bits of the seven-bit CAN address. When the number of nodes on a bus is less than sixteen, the CAN address can be set using only the switch.

For installations with sixteen or more CAN nodes on a network CME 2 can be used to configure Accelnet to use the rotary switch, or combinations of digital inputs and programmed offset in flash memory to configure the drive with a higher CAN node address. For more information on CANopen communications, download the CANopen Manual from the Copley web-site: CANopen Manual

CANOPEN CONNECTORS

Dual RJ-45 connectors that accept standard Ethernet cables are provided for CAN bus connectivity. Pins are wired-through so that drives can be daisy-chained and controlled with a single connection to the user's CAN interface. A CAN terminator should be placed in the last drive in the chain. The XTL-NK connector kit provides a D-Sub adapter that plugs into a CAN controller and has an RJ-45 socket that accepts the Ethernet cable.

ADP-NK CAN CONNECTOR KIT

The kit contains the XTL-CV adapter that converts the CAN interface D-Sub 9M connector to an RJ-45 Ethernet cable socket, plus a 10 ft (3 m) cable and terminator. Both connector pin-outs conform to the CiA DR-303-1 specification.

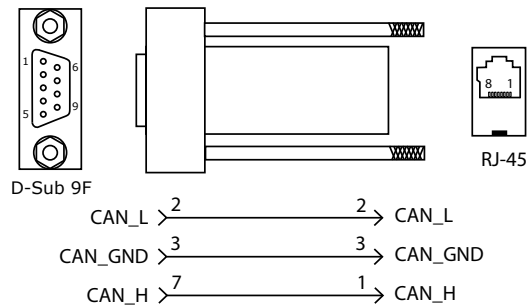
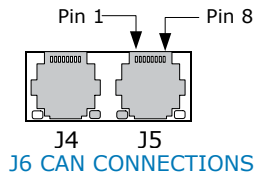

CAN STATUS LED

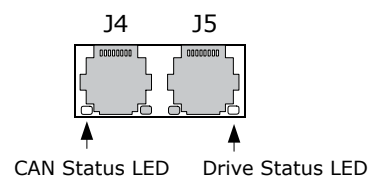
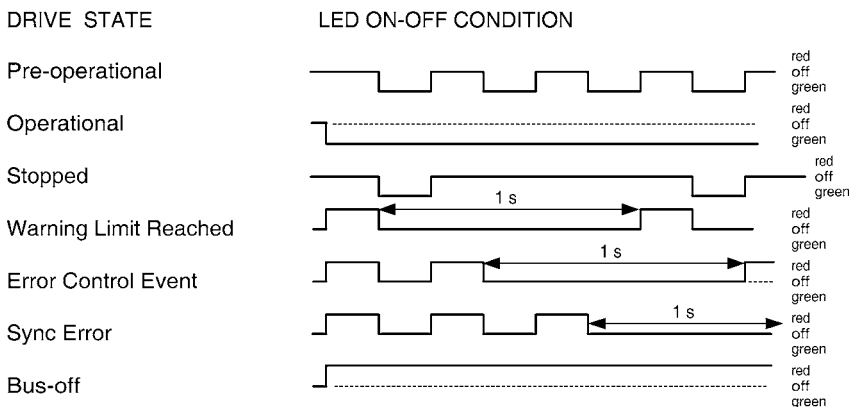

Note: Red & green led on-times do not overlap.
LED color may be red, green, off, or flashing of either color.

COMMUNICATIONS (CONTINUED)

DRIVE STATUS LED

A single bi-color LED gives the state of the drive by changing color, and either blinking or remaining solid.

The possible color and blink combinations are:

- *Green/Solid*: Drive OK and enabled. Will run in response to reference inputs or CANopen commands.
- *Green/Slow-Blinking*: Drive OK but NOT-enabled. Will run when enabled.
- *Green/Fast-Blinking*: Positive or Negative limit switch active. Drive will only move in direction not inhibited by limit switch.
- *Red/Solid*: Transient fault condition. Drive will resume operation when fault is removed.
- *Red/Blinking*: Latching fault. Operation will not resume until drive is Reset.

Drive Fault conditions:

- Over or under-voltage
- Motor over-temperature
- Encoder +5 Vdc fault
- Short-circuits from output to output
- Short-circuits from output to ground
- Internal short circuits
- Drive over-temperature

Faults are programmable to be either transient or latching

COMMAND INPUTS

ANALOG REFERENCE INPUT

A single ± 10 Vdc differential input takes inputs from controllers that use PID or similar compensators, and outputs a current command to the drive. Drive output current or velocity vs. reference input voltage is programmable.

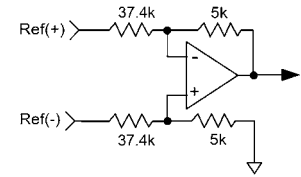

DIGITAL POSITION

Digital position commands can be in either single-ended or differential format. Single-ended signals should be sourced from devices with active pull-up and pull-down to take advantage of the high-speed inputs. Differential inputs have 121 Ω line-terminators.

SINGLE-ENDED PULSE & DIRECTION

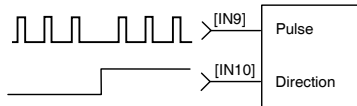

DIFFERENTIAL PULSE & DIRECTION

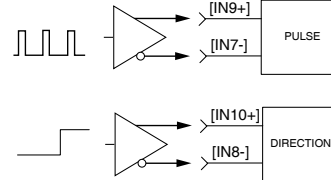

SINGLE-ENDED CU/CD

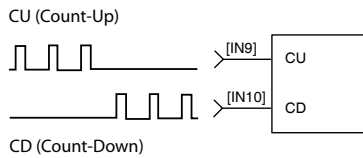

DIFFERENTIAL CU/CD

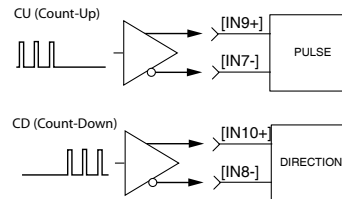

QUAD A/B ENCODER SINGLE-ENDED

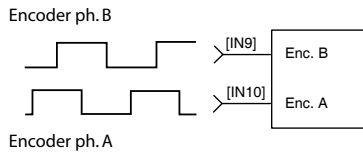

QUAD A/B ENCODER DIFFERENTIAL

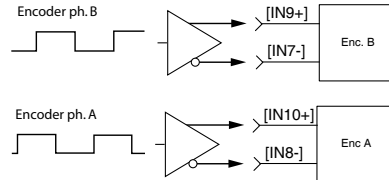

DIGITAL POSITION/VELOCITY/TORQUE

Digital position/velocity/torque PWM commands can be in either single-ended or differential format. Single-ended signals must be sourced from devices with active pull-up and pull-down to take advantage of the high-speed inputs.

SINGLE-ENDED PWM & DIRECTION

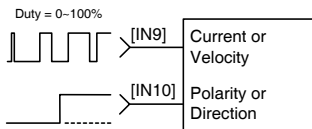

DIFFERENTIAL PWM & DIRECTION

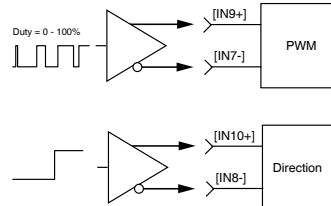

SINGLE-ENDED 50% PWM

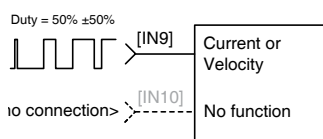

DIFFERENTIAL 50% PWM

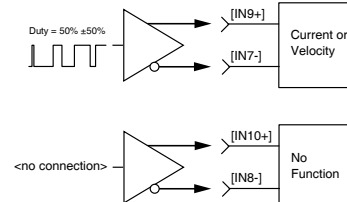

COMMAND INPUTS (CONTINUED)

DIGITAL INPUTS

Accelnet has twelve digital inputs, eleven of which have programmable functions. Input [IN1] is dedicated to the drive Enable function. This is done to prevent accidental programming of the input in such a way that the controller could not shut it down.

Two types of RC filters are used: GP (general purpose) and HS (high speed). Input functions such as Pulse/Dir, CW/CCW, Quad A/B are wired to inputs having the HS filters, and inputs with the GP filters are used for general purpose logic functions, limit switches, and the motor temperature sensor. Programmable functions of the digital inputs include:

- Positive Limit switch
- Negative Limit switch
- Home switch
- Drive Reset
- PWM current or velocity commands
- CAN address bits
- Step & Direction, or CU/CD step motor position commands
- Quad A/B master encoder position commands
- Motor over-temperature
- Motion Profile Abort

PULL-UP/PULL-DOWN CONTROL

In addition to the active level and function for each programmable input, the input resistors are programmable in four groups to either pull up to +5 Vdc, or down to ground. Grounded inputs with HI active levels interface to PLC's that have PNP outputs that source current from +24 Vdc sources. Inputs pulled up to +5 Vdc work with open-collector, or NPN drivers that sink current to ground. The table below shows the PU/PD groups and the inputs they control.

Group	Inputs
A	1,2,3
B	4,5
C	6,7,8
D	9,10,11,12

DIGITAL INPUT CIRCUITS

30 VDC MAX

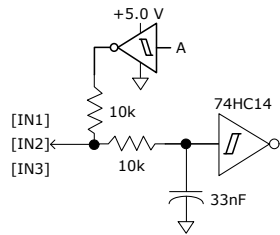

30 VDC MAX

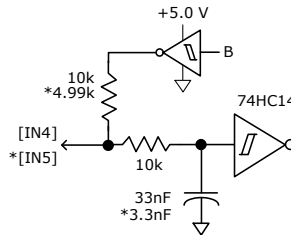

HS (HIGH SPEED) DIGITAL INPUTS

These inputs have all the programmable functions of the GP inputs plus these additional functions on [IN8] & [IN9] which can be configured as single-ended or differential:

- PWM 50%, PWM & Direction for Velocity or Current modes
- Pulse/Direction, CU/CD, or A/B Quad encoder inputs for Position or Camming modes

SINGLE-ENDED

12 Vdc max

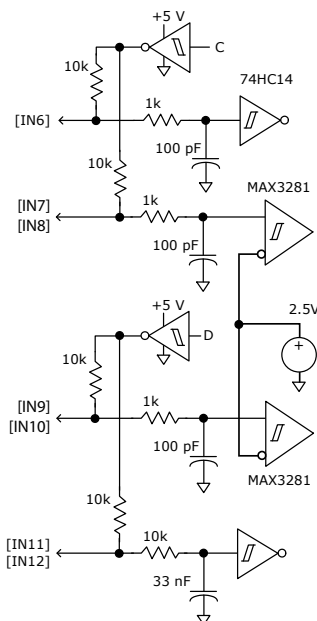

DIFFERENTIAL

12 Vdc max

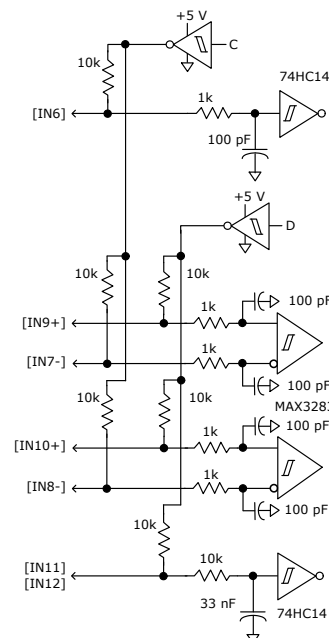

OUTPUTS

DIGITAL OUTPUTS

The digital outputs are open-drain MOSFETs with 1 kΩ pull-up resistors in series with a diode to +5 Vdc. They can sink up to 1 Adc from external loads operating from power supplies to +30 Vdc. The output functions are programmable. The active state of the outputs is programmable to be on or off.

When driving inductive loads such as a relay, an external fly-back diode is required. The internal diode in the output is for driving PLC inputs that are opto-isolated and connected to +24 Vdc. The diode prevents conduction from +24 Vdc through the 1 kΩ resistor to +5 Vdc in the drive. This could turn the PLC input on, giving a false indication of the drive output state.

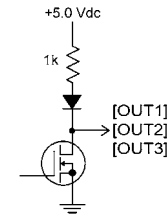

MOTOR CONNECTIONS

Motor connections are of three types: phase, feedback, and thermal sensor. The phase connections carry the drive output currents that drive the motor to produce motion. A thermal sensor that indicates motor overtemperature is used to shut down the drive to protect the motor. Feedback can be digital quad A/B encoder, analog sin/cos encoder, resolver or digital Halls, depending on the version of the drive.

MOTOR PHASE CONNECTIONS

The drive output is a three-phase PWM inverter that converts the DC buss voltage (+HV) into three sinusoidal voltage waveforms that drive the motor phase-coils. Cable should be sized for the continuous current rating of the motor. Motor cabling should use twisted, shielded conductors for CE compliance, and to minimize PWM noise coupling into other circuits. The motor cable shield should connect to motor frame and the drive frame ground terminal (J2-1) for best results.

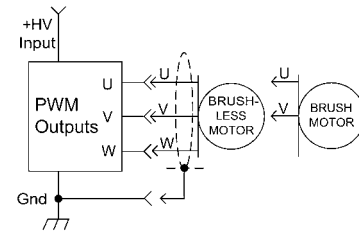

DIGITAL HALL SIGNALS

Hall signals are single-ended signals that provide absolute feedback within one electrical cycle of the motor. There are three of them (U, V, & W) and they may be sourced by magnetic sensors in the motor, or by encoders that have Hall tracks as part of the encoder disc. They typically operate at much lower frequencies than the motor encoder signals, and are used for commutation-initialization after startup, and for checking the motor phasing after the amplifier has switched to sinusoidal commutation. Resolver models can also take Hall signal at inputs [IN6~8]. See page 16 for connections.

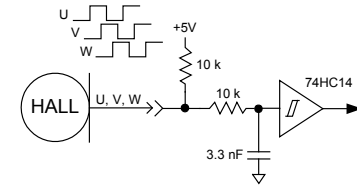

DIGITAL ENCODERS

The quad A/B encoder interface is a differential line-receiver with R-C filtering on the inputs. Encoders with differential outputs are required because they are less susceptible to noise that can degrade single-ended outputs. Encoder cables should use twisted-pairs for each signal pair: A & /A, B & /B, X & /X. An overall shield should be used, and for longer cables, shields for individual pairs may be necessary to guarantee signal integrity.

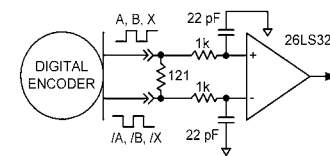

ANALOG ENCODER (-S OPTION)

Accelnet supports analog encoder signals for position feedback. The Sin and Cos inputs are differential with 121 Ω terminating resistors and accept 1.0 Vp-p signals in the A/B format used by encoders with analog outputs such as Heidenhain, Stegman, and Renishaw. When Copley's ServoTube motors are used the analog encoder supplies both commutation and incremental position feedback.

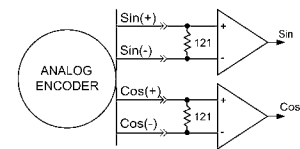

RESOLVER (-R OPTION)

Connections to the resolver should be made with shielded cable that uses three twisted-pairs. Once connected, resolver set up, motor phasing, and other commissioning adjustments are made with CME 2 software. There are no hardware adjustments.

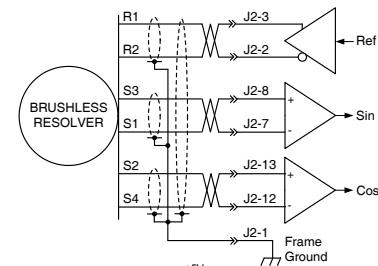

MOTOR TEMPERATURE SENSOR

Digital input [IN5] is for use with a motor overtemperature switch. The input should be programmed as a pull-up to +5 Vdc if the motor switch is grounded when cold, and open or high-impedance when over-heating.

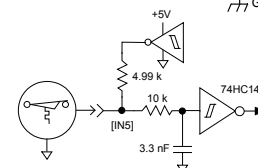

ANALOG HALLS (-S OPTION) + DIGITAL ENCODER

For position feedback with higher resolution than is possible by interpolating analog Halls, a digital incremental encoder is connected to the multi-mode port. The Halls are then used for commutation and the multi-mode port is programmed as a differential input for the Secondary Incremental motor encoder.

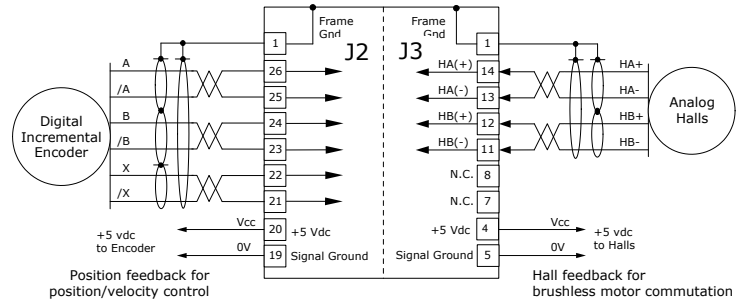

MULTI-MODE ENCODER PORT

This port consists of three differential input/output channels that take their functions from the Basic Setup of the drive. On drives with quad A/B encoder feedback, the port works as an output buffering the signals from the encoder. With resolver or sin/cos encoder versions, the feedback is converted to quad A/B signals with programmable resolution. These signals can then be fed back to an external motion controller that closes the position or velocity loops. As an input, the port can take quad A/B signals to produce a dual-loop position control system or use the signals as master-encoder feedback in camming mode. In addition, the port can take stepper command signals (CU/CD or Pulse/Direction) in differential format.

AS BUFFERED OUTPUTS FROM A DIGITAL QUADRATURE FEEDBACK ENCODER

When using a digital quadrature feedback encoder, the A/B/X signals drive the multi-mode port output buffers directly. This is useful in systems that use external controllers that also need the motor feedback encoder signals because these now come from J7, the Control connector. In addition to eliminating "Y" cabling where the motor feedback cable has to split to connect to both controller and motor, the buffered outputs reduce loading on the feedback cable that could occur if the motor encoder had to drive two differential inputs in parallel, each with it's own 121 ohm terminating resistor.

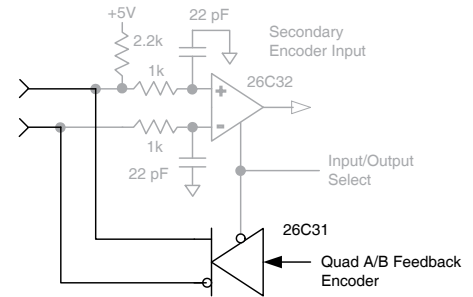

AS EMULATED QUAD A/B/X ENCODER OUTPUTS FROM AN ANALOG SIN/COS FEEDBACK ENCODER

Analog sin/cos signals are interpolated in the drive with programmable resolution. The incremental position data is then converted back into digital quadrature format which drives the multi-mode port output buffers. Some analog encoders also produce a digital index pulse which is connected directly to the port's output buffer. The result is digital quadrature A/B/X signals that can be used as feedback to an external control system.

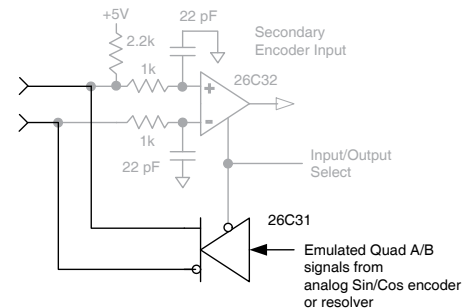

AS A MASTER OR CAMMING ENCODER INPUT FROM A DIGITAL QUADRATURE ENCODER

When operating in position mode the multi-mode port can accept digital command signals from external encoders. These can be used to drive cam tables, or as master-encoder signals when operating in a master/slave configuration.

AS DIGITAL COMMAND INPUTS IN PULSE/DIRECTION, PULSE-UP/PULSE-DOWN, OR DIGITAL QUADRATURE ENCODER FORMAT

The multi-mode port can also be used when digital command signals are in a differential format. These are the signals that typically go to [IN9] and [IN10] when they are single-ended. But, at higher frequencies these are likely to be differential signals in which case the multi-mode port can be used.

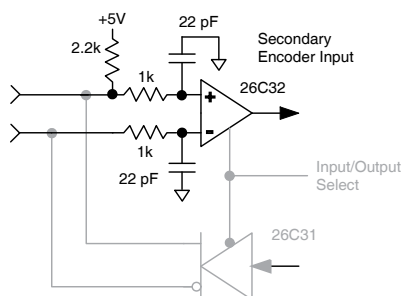

DRIVE CONNECTIONS

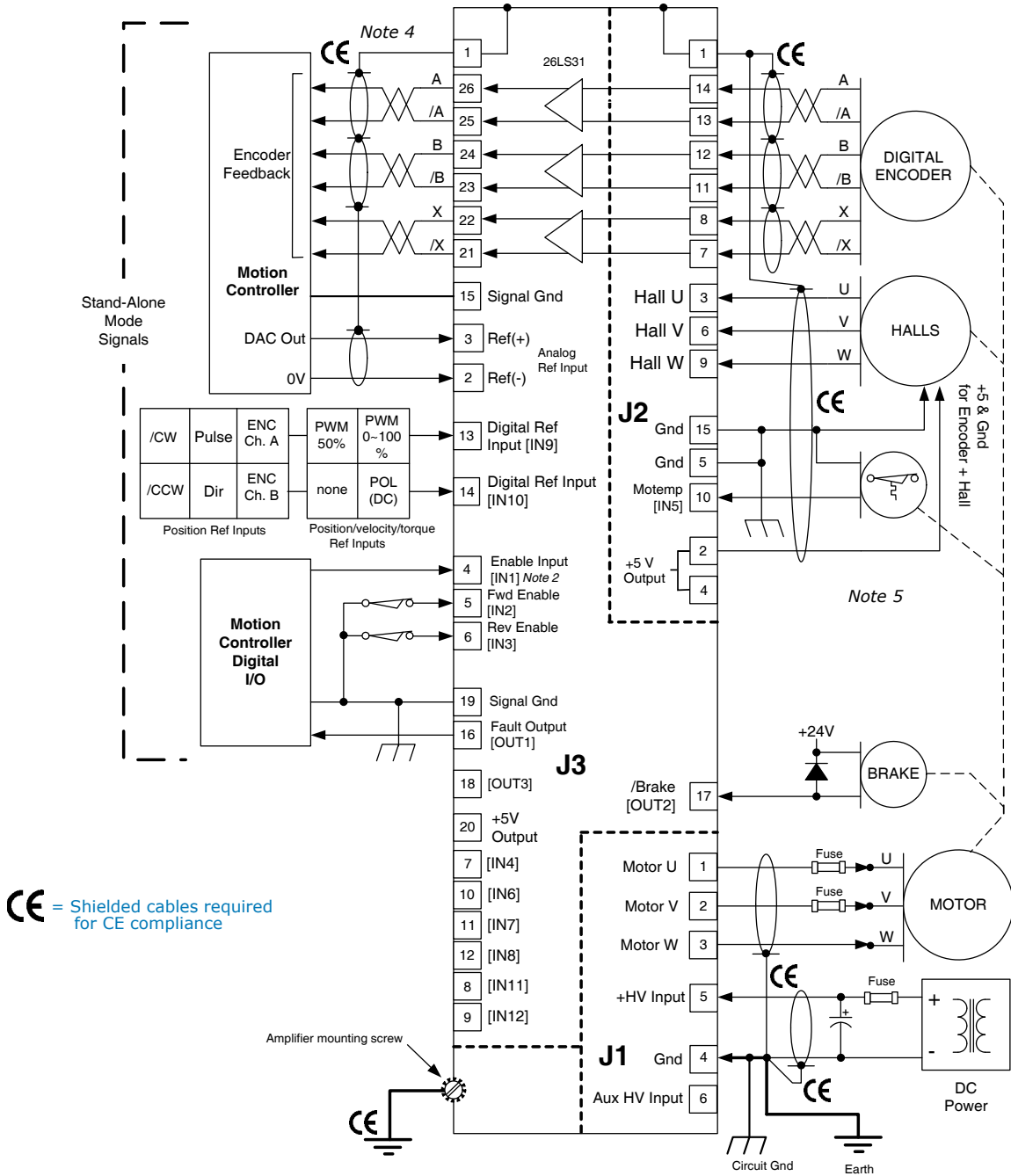

CE = Shielded cables required for CE compliance

NOTES

1. The functions of input signals on J2-10, and J3-5,6,7,8,9,10,11,12,13, and 14 are programmable. Default functions are shown.
2. The function of [IN1] on J3-4 is always Drive Enable and is not programmable
3. Pins J3-20, J2-2, and J2-4 all connect to the same +5 Vdc @ 400 mAdc power source. Total current drawn from both pins cannot exceed 400 mAdc.
4. Multi-mode encoder port (J3-21~26) is shown configured for buffered-output of a digital primary motor encoder.

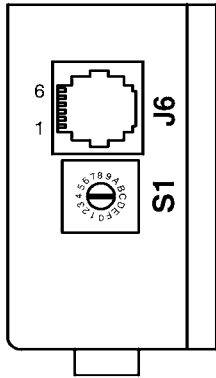

J6 RS-232

PIN	SIGNAL
1	No Connection
2	RxD
3	Signal Ground
4	Signal Ground
5	TxD
6	No Connection

J6 CABLE CONNECTOR

RJ-11 style, male, 6 position

Cable: 6-conductor modular type

J4-J4 CAN BUS

PIN	SIGNAL
1	CAN_H
2	CAN_L
3	CAN_GND
4	No Connection
5	Reserved
6	(CAN_SHLD) ¹
7	CAN_GND
8	(CAN_V+) ¹

J4, J5 CABLE CONNECTOR:

RJ-45 style, male, 8 position

Cable: 8-conductor, modular type

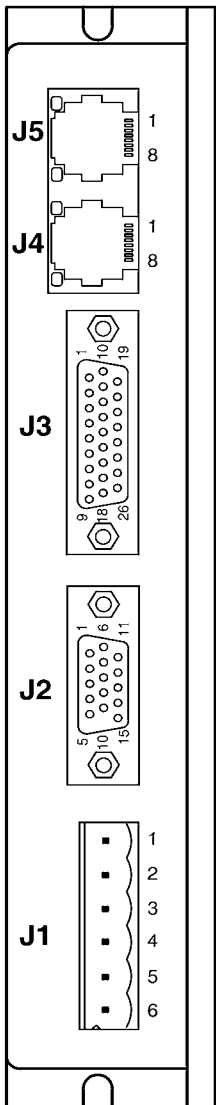

J3 CONTROL SIGNALS

PIN	SIGNAL	PIN	SIGNAL	PIN	SIGNAL
1	Frame Gnd	10	[IN6] HS	19	Signal Gnd
2	Ref(-)	11	[IN7] HS	20	+5 Vdc (Note 1)
3	Ref(+)	12	[IN8] HS	21	Multi Encoder /X
4	[IN1] Enable	13	[IN9] HS	22	Multi Encoder X
5	[IN2] GP	14	[IN10] HS	23	Multi Encoder /B
6	[IN3] GP	15	Signal Gnd	24	Multi Encoder B
7	[IN4] GP	16	[OUT1]	25	Multi Encoder /A
8	[IN11] GP	17	[OUT2]	26	Multi Encoder A
9	[IN12] GP	18	[OUT3]		

J3 CABLE CONNECTOR:

High-Density D-Sub
26 Position, Male
#4-40 locking screws

J2 MOTOR FEEDBACK

PIN	SIGNAL	PIN	SIGNAL	PIN	SIGNAL
1	Frame Gnd	6	Hall V	11	Encoder /B
2	+5 Vdc (Note 1)	7	Encoder /X	12	Encoder B
3	Hall U	8	Encoder X	13	Encoder /A
4	+5 Vdc (Note 1)	9	Hall W	14	Encoder A
5	Signal Gnd	10	[IN5] Motemp	15	Signal Gnd

J2 CABLE CONNECTOR:

High-Density D-Sub
15 Position, Male
#4-40 locking screws

J1: MOTOR & POWER

PIN	SIGNAL
1	Motor U Output
2	Motor V Output
3	Motor W Output
4	Ground (HV, Signal)
5	+HV Input
6	Aux HV Input

J1 CABLE CONNECTOR:

Terminal block, 6 position, 5.08 mm, black
UL rated 300V, 15A:

Amphenol PCD: ELFP06210

Molex: 39530-0006

TE Connectivity: 796635-6

DRIVE CONNECTIONS

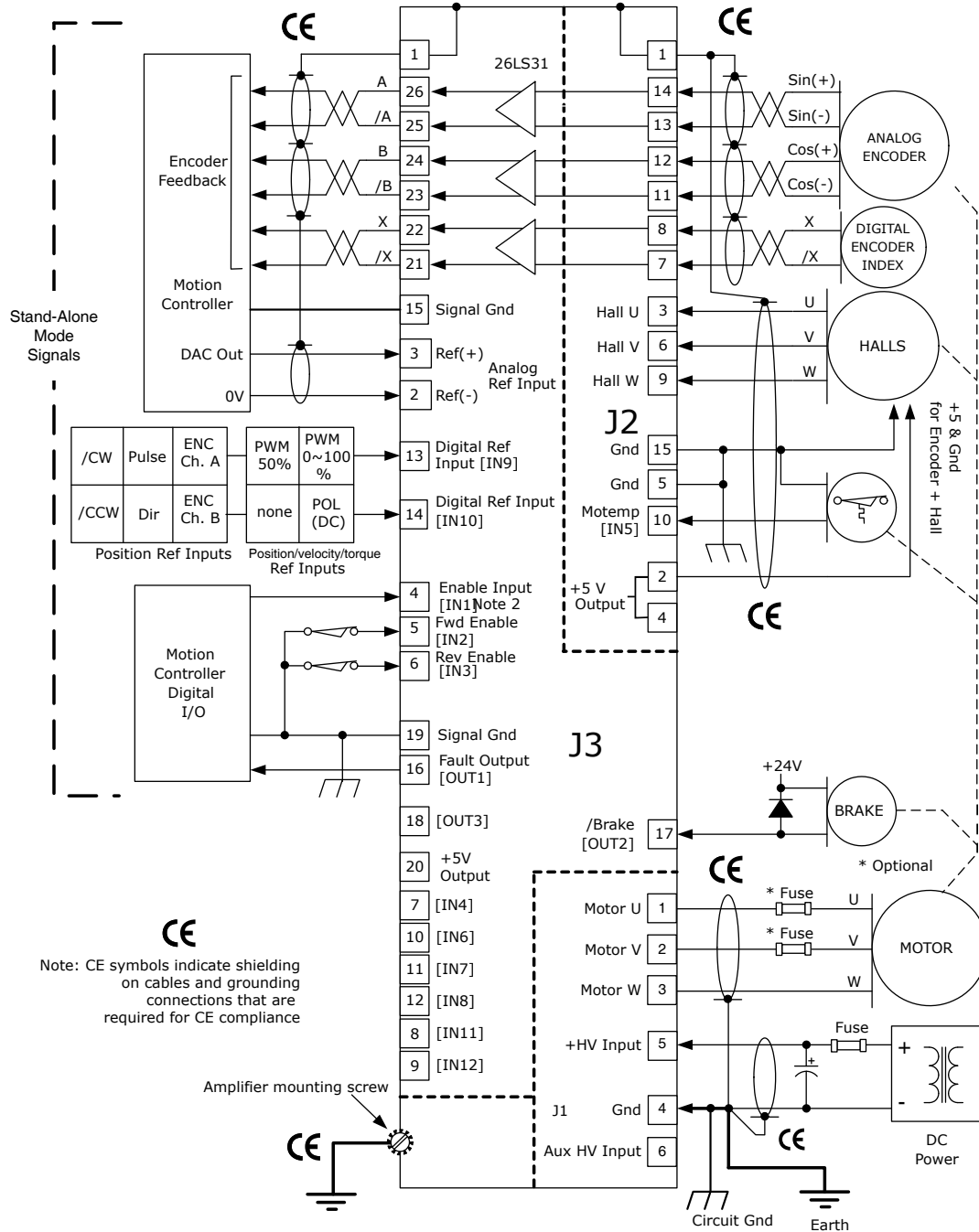

NOTES

1. The functions of input signals on J2-10, and J3-5,6,7,8,9,10,11,12,13, and 14 are programmable. Default functions are shown.
2. The function of [IN1] on J3-4 is always Drive Enable and is not programmable
3. Pins J3-20, J2-2, and J2-4 all connect to the same +5 Vdc @ 400 mAdc power source. Total current drawn from both pins cannot exceed 400 mAdc.
4. Multi-mode encoder port (J3-21~26) is shown configured for buffered-output of a digital primary motor encoder. Page 11 shows connections for analog Hall commutation with digital incremental position feedback.

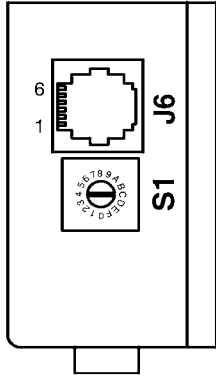

J6 RS-232

PIN	SIGNAL
1	No Connection
2	RxD
3	Signal Ground
4	Signal Ground
5	TxD
6	No Connection

J6 CABLE CONNECTOR

RJ-11 style, male, 6 position

Cable: 6-conductor modular type

J4-J4 CAN BUS

PIN	SIGNAL
1	CAN_H
2	CAN_L
3	CAN_GND
4	No Connection
5	Reserved
6	(CAN_SHLD) ¹
7	CAN_GND
8	(CAN_V+) ¹

J4, J5 CABLE CONNECTOR:

RJ-45 style, male, 8 position

Cable: 8-conductor, modular type

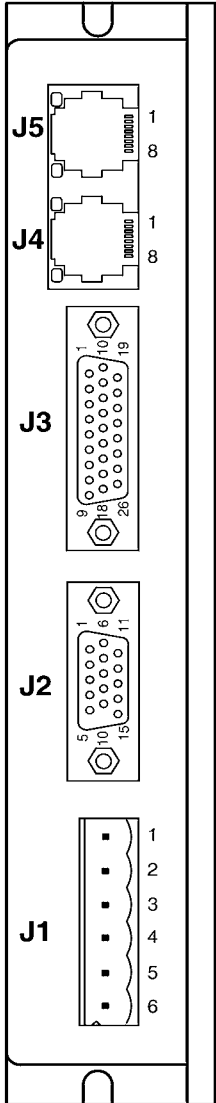

J3 CONTROL SIGNALS

PIN	SIGNAL	PIN	SIGNAL	PIN	SIGNAL
1	Frame Gnd	10	[IN6] HS	19	Signal Gnd
2	Ref(-)	11	[IN7] HS	20	+5 Vdc (Note 1)
3	Ref(+)	12	[IN8] HS	21	Multi Encoder /X
4	[IN1] Enable	13	[IN9] HS	22	Multi Encoder X
5	[IN2] GP	14	[IN10] HS	23	Multi Encoder /B
6	[IN3] GP	15	Signal Gnd	24	Multi Encoder B
7	[IN4] GP	16	[OUT1]	25	Multi Encoder /A
8	[IN11] GP	17	[OUT2]	26	Multi Encoder A
9	[IN12] GP	18	[OUT3]		

J3 CABLE CONNECTOR:
High-Density D-Sub
26 Position, Male

J2 MOTOR FEEDBACK

PIN	SIGNAL	PIN	SIGNAL	PIN	SIGNAL
1	Frame Gnd	6	Hall V	11	Encoder Cos(-)
2	+5 Vdc (Note 1)	7	Encoder /X	12	Encoder Cos(+)
3	Hall U	8	Encoder X	13	Encoder Sin(-)
4	+5 Vdc (Note 1)	9	Hall W	14	Encoder Sin(+)
5	Signal Gnd	10	[IN5] Motemp	15	Signal Gnd

J2 CABLE CONNECTOR:
High-Density D-Sub
15 Position, Male

J1: MOTOR & POWER

PIN	SIGNAL
1	Motor U Output
2	Motor V Output
3	Motor W Output
4	Ground (HV, Signal)
5	+HV Input
6	Aux HV Input

J1 CABLE CONNECTOR:

Terminal block, 6 position, 5.08 mm, black
UL rated 300V, 15A:
Amphenol PCD: ELFP06210
Molex: 39530-0006
TE Connectivity: 796635-6

DRIVE CONNECTIONS

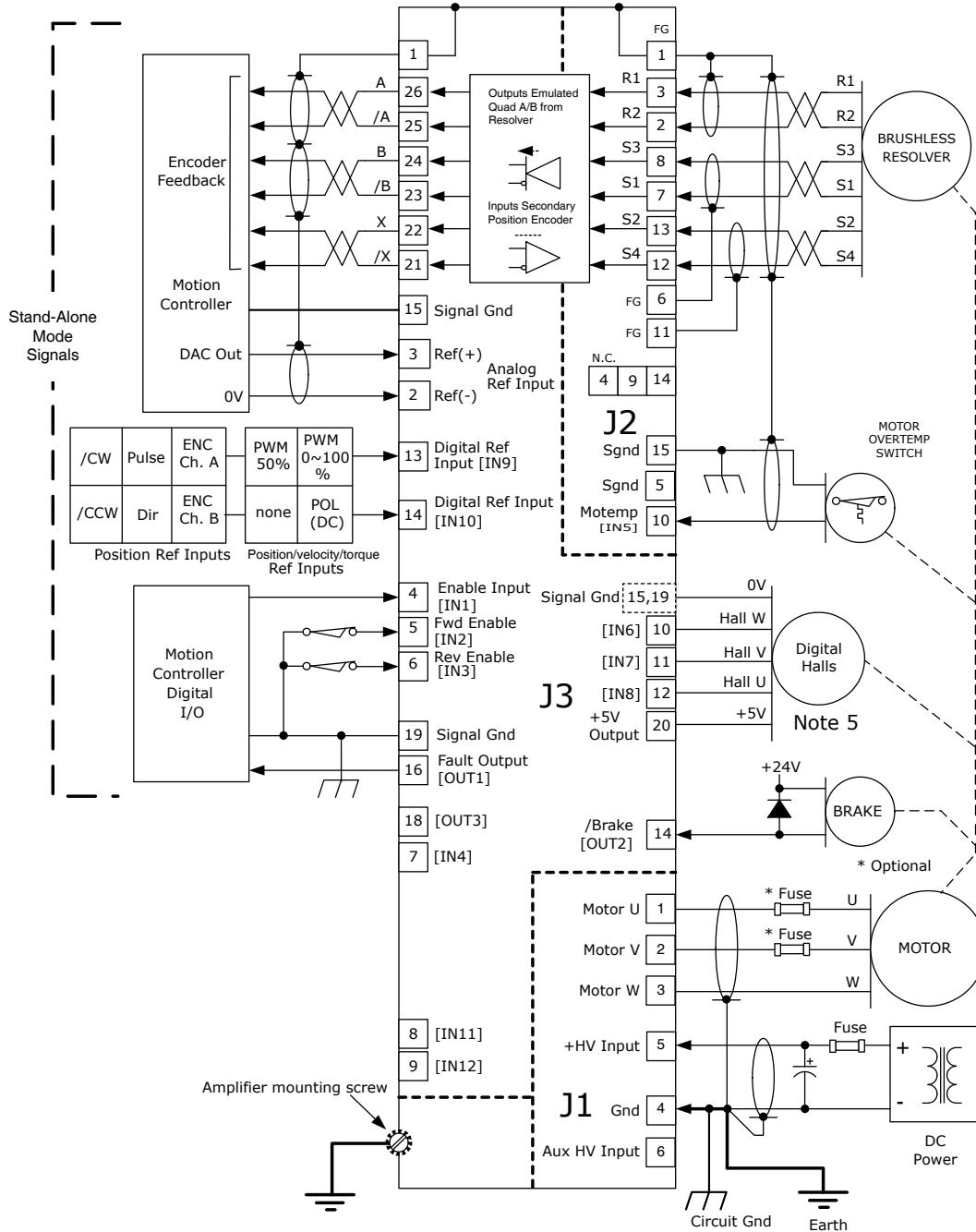

NOTES

1. The functions of input signals on J2-10, and J3-5,6,7,8,9,10,11,12,13, and 14 are programmable. Default functions are shown.
2. The function of [IN1] on J3-4 is always Drive Enable and is not programmable
3. Pins J3-20 and J2-2 both connect to the same +5 Vdc @ 400 mAdc power source. Total current drawn from both pins cannot exceed 400 mAdc.
4. Multi-mode encoder port (J3-21~26) is shown configured for buffered-output of a digital primary motor encoder.
5. Usage of [IN6~8] for Hall sensors is optional. If not used for Halls, these are programmable, high-speed inputs. Signal Ground for Halls can use J3-15, J3-19, or J2-5.

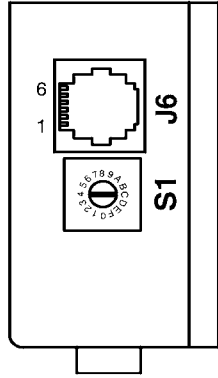

J6 RS-232

PIN	SIGNAL
1	No Connection
2	RxD
3	Signal Ground
4	Signal Ground
5	TxD
6	No Connection

J6 CABLE CONNECTOR

RJ-11 style, male, 6 position
Cable: 6-conductor modular type

J4-J5 CAN BUS

PIN	SIGNAL
1	CAN_H
2	CAN_L
3	CAN_GND
4	No Connection
5	Reserved
6	(CAN_SHLD) ¹
7	CAN_GND
8	(CAN_V+) ¹

J4, J5 CABLE CONNECTOR:

RJ-45 style, male, 8 position
Cable: 8-conductor, modular type

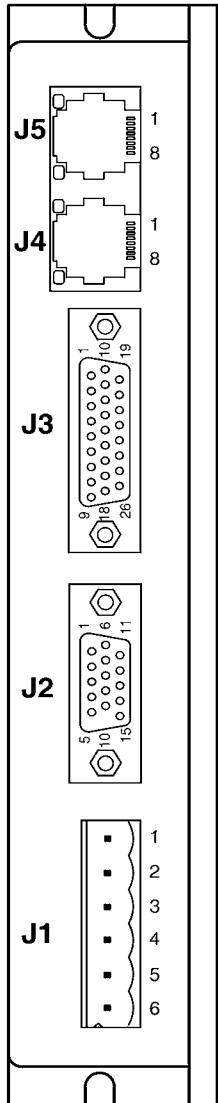

J3 CONTROL SIGNALS

PIN	SIGNAL	PIN	SIGNAL	PIN	SIGNAL
1	Frame Gnd	10	[IN6] HS	19	Signal Gnd
2	Ref(-)	11	[IN7] HS	20	+5 Vdc (Note 1)
3	Ref(+)	12	[IN8] HS	21	Multi Encoder /X
4	[IN1] Enable	13	[IN9] HS	22	Multi Encoder X
5	[IN2] GP	14	[IN10] HS	23	Multi Encoder /B
6	[IN3] GP	15	Signal Gnd	24	Multi Encoder B
7	[IN4] GP	16	[OUT1]	25	Multi Encoder /A
8	[IN11] GP	17	[OUT2]	26	Multi Encoder A
9	[IN12] GP	18	[OUT3]		

J3 CABLE CONNECTOR:
High-Density D-Sub
26 Position, Male

J2 MOTOR FEEDBACK

PIN	SIGNAL	PIN	SIGNAL	PIN	SIGNAL
1	Frame Gnd	6	Frame Gnd	11	Frame Gnd
2	Ref(-) Output R2	7	Sin(-) Input S1	12	Cos(-) Input S4
3	Ref(+) Output R1	8	Sin(+) Input S3	13	Cos(+) input S2
4	N.C.	9	N.C.	14	N.C.
5	Signal Gnd	10	[IN5] Motemp	15	Signal Gnd

J2 CABLE CONNECTOR:
High-Density D-Sub
15 Position, Male

J1: MOTOR & POWER

PIN	SIGNAL
1	Motor U Output
2	Motor V Output
3	Motor W Output
4	Ground (HV, Signal)
5	+HV Input
6	Aux HV Input

J1 CABLE CONNECTOR:

Terminal block, 6 position, 5.08 mm, black
UL rated 300V, 15A:
Amphenol PCD: ELFP06210
Molex: 39530-0006
TE Connectivity: 796635-6

GROUNDING CONSIDERATIONS

Power and control circuits in *Accelnet* share a common circuit-ground (Gnd on J1-4, and Signal Ground on J2-2, 10, 15, 20, and J3-2, 23). Input logic circuits are referenced to Signal Ground, as are analog Reference inputs, digital outputs, encoder and Hall signals. For this reason, drive Gnd terminals should connect to the users' common ground system so that signals between drive and controller are at the same common potential, and to minimize noise. The system ground should, in turn, connect to an earthing conductor at some point so that the whole system is referenced to "earth". The CAN ports are optically isolated from the drive circuits.

Because current flow through conductors produces voltage-drops across them, it is best to connect the drive HV Return to system earth, or circuit-common through the shortest path, and to leave the power-supply floating. In this way, the power supply (-) terminal connects to ground at the drive HV Return terminals, but the voltage drops across the cables will not appear at the drive ground, but at the power supply negative terminal where they will have less effect.

Motor phase currents are balanced, but currents can flow between the PWM outputs, and the motor cable shield. To minimize the effects of these currents on nearby circuits, the cable shield should connect to Gnd (J1-4).

The drive case does not connect to any drive circuits. Connections to the case are provided on connectors J2-1, and J3-1. Cables to these connectors should be shielded for CE compliance, and the shields should connect to these terminals. When installed, the drive case should connect to the system chassis. This maximizes the shielding effect of the case, and provides a path to ground for noise currents that may occur in the cable shields.

Signals from controller to drive are referenced to +5 Vdc, and other power supplies in user equipment. These power supplies should also connect to system ground and earth at some point so that they are at same potential as the drive circuits.

The final configuration should embody three current-carrying loops. First, the power supply currents flowing into and out of the drive at the +HV and Gnd pins on J1. Second the drive outputs driving currents into and out of the motor phases, and motor shield currents circulating between the U, V, and W outputs and Gnd. And, lastly, logic and signal currents connected to the drive control inputs and outputs.

For CE compliance and operator safety, the drive should be earthed by using external tooth lockwashers under the mounting screws. These will make contact with the aluminum chassis through the anodized finish to connect the chassis to the equipment frame ground.

POWER SUPPLIES

Accelnet operates typically from transformer-isolated, unregulated DC power supplies. These should be sized such that the maximum output voltage under high-line and no-load conditions does not exceed the drives maximum voltage rating. Power supply rating depends on the power delivered to the load by the drive. In many cases, the continuous power output of the drive is considerably higher than the actual power required by an incremental motion application.

Operation from regulated switching power supplies is possible if a diode is placed between the power supply and drive to prevent regenerative energy from reaching the output of the supply. If this is done, there must be external capacitance between the diode and drive.

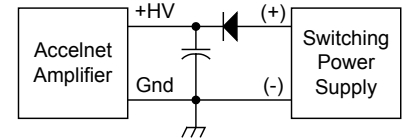

AUXILIARY HV POWER

Accelnet has an input for AUX- HV. This is a voltage that can keep the drive communications and feedback circuits active when the PWM output stage has been disabled by removing the main +HV supply. This can occur during EMO (Emergency Off) conditions where the +HV supply must be removed from the drive and powered-down to ensure operator safety. The AUX HV input operates from any DC voltage that is within the operating voltage range of the drive and powers the DC/DC converter that supplies operating voltages to the drive DSP and control circuits.

When the drive +HV voltage is greater than the AUX-HV voltage it will power the DC/DC converter. Under these conditions the AUX-HV input will draw no current.

MOUNTING & COOLING

Accelnet has slots for mounting to panels at 0° or 90°. Cooling is by conduction from drive heatplate to mounting surface, or by convection to ambient.

A heatsink (optional) is required for the drive to deliver the rated continuous output current. Depending on the drive mounting and cooling means this may not be required.

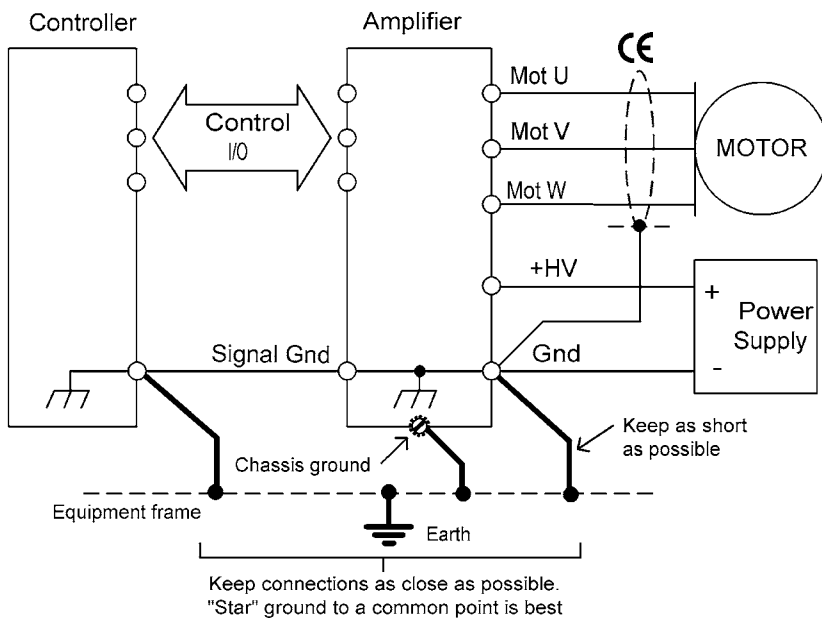

 = Shielded cables required for CE compliance

GROUNDING & SHIELDING FOR CE

Grounding and shielding are the means of controlling the emission of radio frequency energy from the drive so that it does not interfere with other electronic equipment.

The use of shielded cables to connect the drive to motors and feedback devices is a way of extending the chassis of the drive out to these devices so that the conductors carrying noise generated by the drive are completely enclosed by a conductive shield.

The process begins at the connector J1 of the drive. When possible, it is best to ground the (-) HV terminal to the equipment earth ground with as short a connection as possible. The drives' PWM outputs produce current pulses in the wires between drive and power supply. By grounding the power supply at the drive end of the cables, this noise will not appear between earth ground and drive circuit ground. And, using shielded cable between drive and power supply will provide a return path for noise produced in the cables that might otherwise radiate to adjacent equipment.

The shield of the motor cable should also connect to either J1-4, or to a nearby star ground at the chassis where the power-supply (-) terminal connects. Connecting the shields of the motor cable to the motor frame completes the return path for noise that is capacitively coupled to the motor frame.

Next, ground the motor heatplate using an external-tooth locking washer. This will penetrate the anodized finish of the heatplate (which is an electrical insulator) and make good electrical contact with the aluminum plate. Grounding the heatplate in this way shortens the path from drive to earth ground and further reduces emissions.

Shield should also be added to the cables from the motion controller or control system, and from the feedback device on the motor.

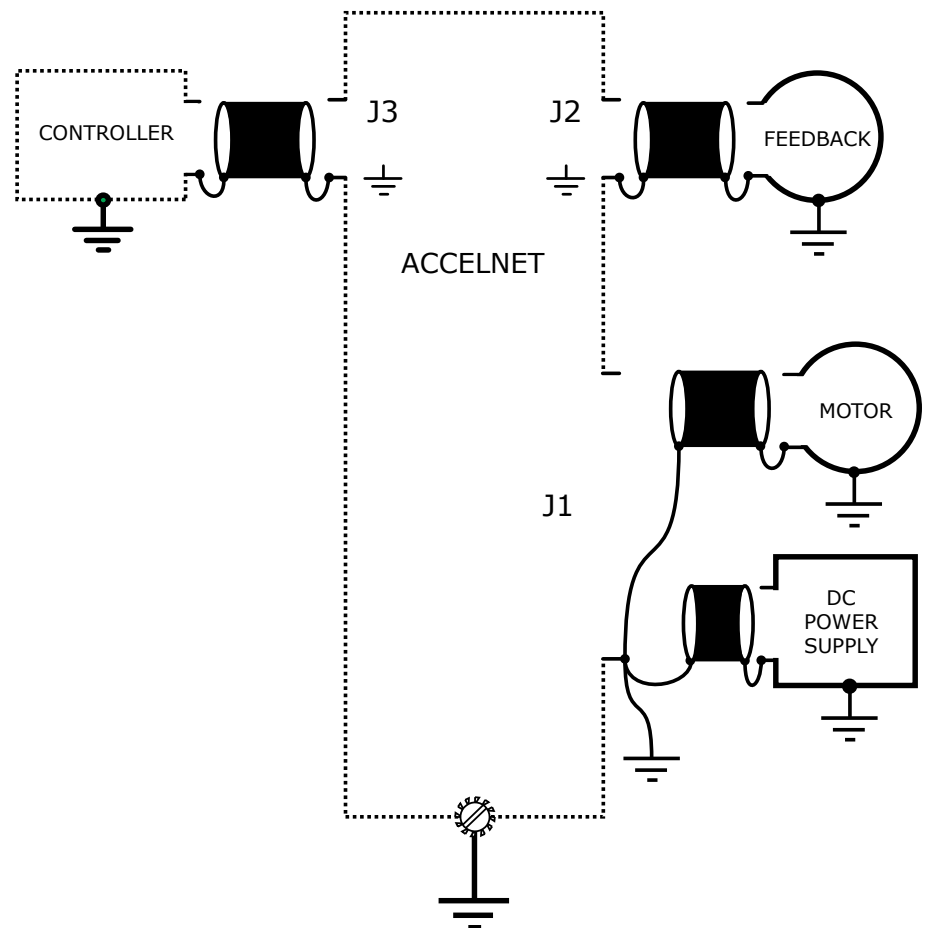

Notes:

- 1) Shielded cables required for CE are shown in the diagram above.

CANOPEN CONFIGURATION

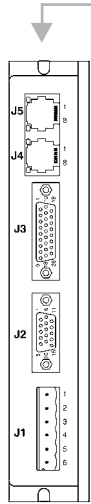

SERIAL CABLE KIT ⁽¹⁾

SER-CK

DB-9 TO RJ-45 ADAPTER & 10 FT CABLE ⁽²⁾

CAN NETWORK CABLE ⁽³⁾

ADP-NC-10 (10 ft)
ADP-NC-01 (1 ft)

CAN TERMINATOR ⁽²⁾

(for last node on CAN bus)

HV/MOTOR, FEEDBACK & CONTROL CONNECTOR KIT

ADP-CK

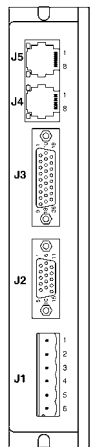

Multiple drives are connected as nodes on a CAN bus

Individual drives are configured using an RS-232 connection and CME 2™ software

Notes:

1. Only one SER-CK is needed per installation
2. Included in CANopen Network Kit ADP-NK
3. Order one cable (1 or 10 ft) for each additional drive



POWER SUPPLY

Mains-isolated DC
Required for all systems
User-supplied

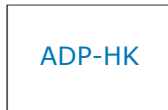

HEATSINK

(Optional)

PART NUMBER	DESCRIPTION
ADP-055-18	Accelnet Servo drive, 55 Vdc, 6/18 A
ADP-090-09	Accelnet Servo drive, 90 Vdc 3/9 A
ADP-090-18	Accelnet Servo drive, 90 Vdc, 6/18 A
ADP-090-36	Accelnet Servo drive, 90 Vdc, 12/36 A
ADP-180-09	Accelnet Servo drive, 180 Vdc, 3/9 A
ADP-180-18	Accelnet Servo drive, 180 Vdc, 6/18 A
ADP-CK	Connector Kit for Accelnet (P1 plug, and plugs with soldercups & backshells for P2 & P3)
ADP-NK	CAN Network Kit (Sub-D 9F to RJ-45 adapter, 10 ft. modular cable, and CAN terminator)
ADP-NC-10	CAN network cable, 10 ft (3 m)
ADP-NC-01	CAN network cable, 1 ft (0.3 m)
CME 2	CD with CME 2 Configuration Software
SER-CK	RS-232 Cable Kit
ADP-HK	Heatsink (optional)

Add -S to part numbers above for sin/cos feedback (*ServoTube* motors)
Add -R to part numbers for resolver feedback

STAND-ALONE CONFIGURATION

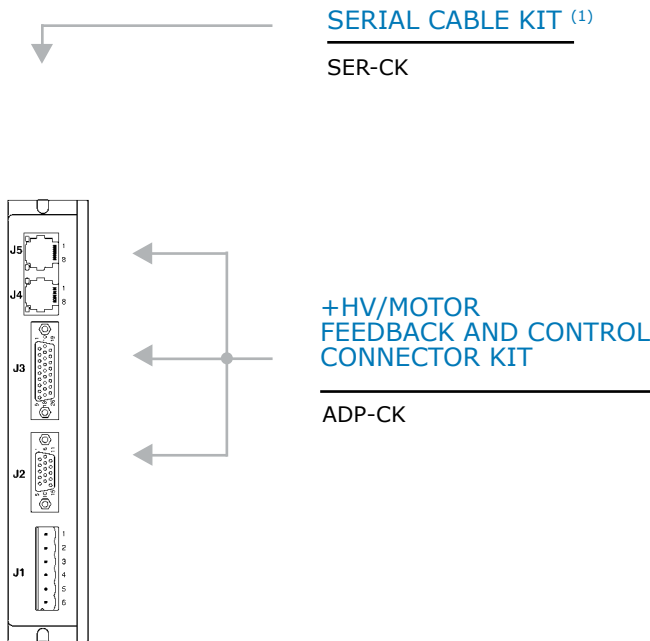

Current or Velocity Mode Signals:
 PWM & Polarity
 PWM 50%
 ±10V Analog

Position-mode Signals:
 Step/Direction
 CW/CCW
 ±10V Analog

Electronic Gearing Signals:
 A/B Quadrature encoder

CME 2™ is used for setup and configuration.

+HV

POWER SUPPLY
 Mains-isolated DC
 Required for all systems
 User-supplied

ADP-HK

HEATSINK
 (Optional)

PART NUMBER	DESCRIPTION
ADP-055-18	Accelnet Servo drive, 55 Vdc, 6/18 A
ADP-090-09	Accelnet Servo drive, 90 Vdc 3/9 A
ADP-090-18	Accelnet Servo drive, 90 Vdc, 6/18 A
ADP-090-36	Accelnet Servo drive, 90 Vdc, 12/36 A
ADP-180-09	Accelnet Servo drive, 180 Vdc, 3/9 A
ADP-180-18	Accelnet Servo drive, 180 Vdc, 6/18 A
ADP-CK	Connector Kit for Accelnet (P1 plug, and plugs with soldercups & backshells for P2 & P3)
CME 2	CD with CME 2 Configuration Software
SER-CK	RS-232 Cable Kit
ADP-HK	Heatsink (optional)

Add -S to part numbers above for sin/cos feedback (*ServoTube* motors)
 Add -R to part numbers for resolver feedback

POWER DISSIPATION

The charts on this page show the drive internal power dissipation for the *Accelnet* models under differing power supply and output current conditions. Drive output current is calculated from the motion profile, motor, and load conditions. The values on the chart represent the RMS (root-mean-square) current that the drive would provide during operation. The +HV values are for the average DC voltage of the drive power supply.

When +HV and drive output current are known, the drive power dissipation can be found from the chart. Once this is done use the data on the facing page to find drive thermal resistance. From this calculate the maximum ambient operating temperature. If this result is lower than the known maximum ambient temperature then a mounting with a lower thermal resistance must be used.

When the drive is disabled the power dissipation is shown on the chart as "Off". Note that this is a different value than that of an drive that is "On" but outputting 0 A current.

55 & 90 VDC MODELS

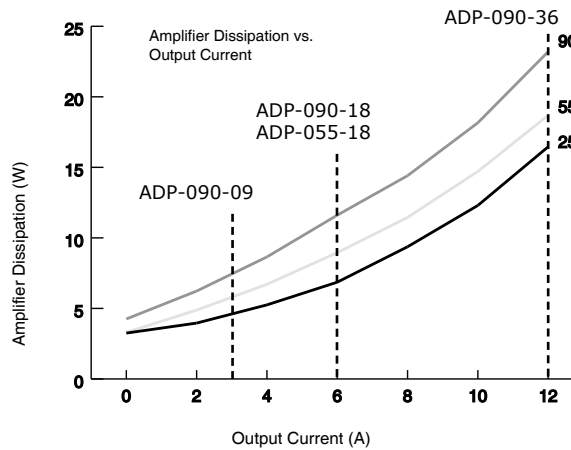

ADP-180-18 MODEL

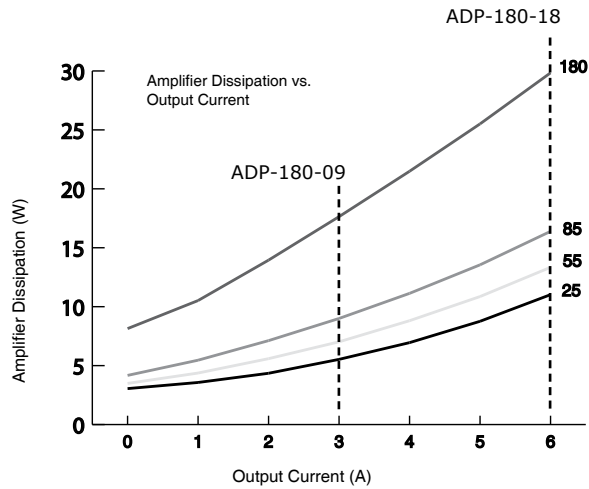

ADP-180-30 MODEL

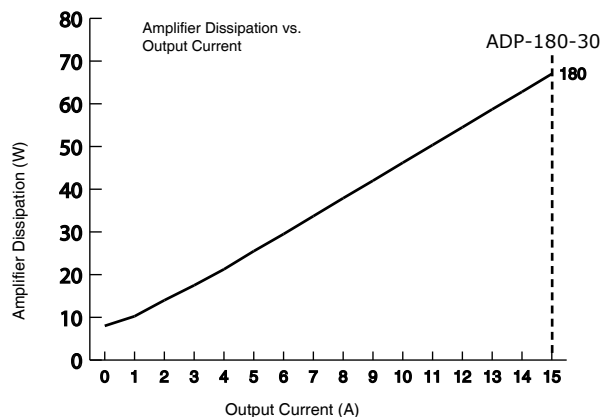

MOUNTING

Thermal data for convection-cooling with a heatsink assumes a vertical mounting of the drive on a thermally conducting surface. Heatsink fins run parallel to the long axis of the drive. When fan-cooling is used vertical mounting is not necessary to guarantee thermal performance of the heatsink.

THERMAL RESISTANCE

Thermal resistance is a measure of the temperature rise of the drive heatplate due to power dissipation in the drive. It is expressed in units of °C/W where the degrees are the temperature rise *above ambient*.

E.g., an drive dissipating 16 W mounted with no heatsink or fan would see a temperature rise of 46 °C above ambient based on the thermal resistance of 2.9 °C/W. Using the drive maximum heatplate temperature of 70 °C and subtracting 46 °C from that would give 24 °C as the maximum ambient temperature the drive in which the amplifier could operate before going into thermal shutdown. To operate at higher ambient temperatures a heatsink or forced-air would be required.

TOP VIEW
VERTICAL MOUNTING
WITH FAN

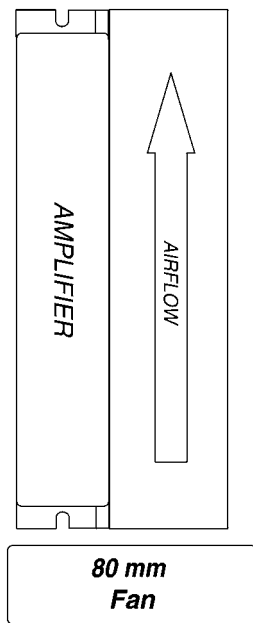

END VIEWS
VERTICAL MOUNTING

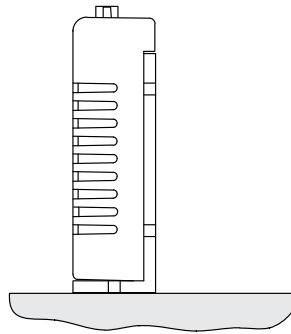

NO HEATSINK, NO FAN	°C/W
CONVECTION	2.9

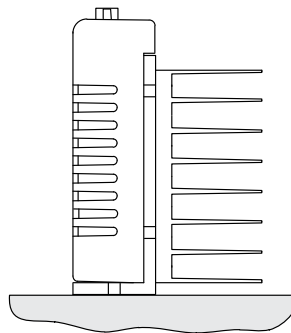

HEATSINK, NO FAN	°C/W
CONVECTION	1.7

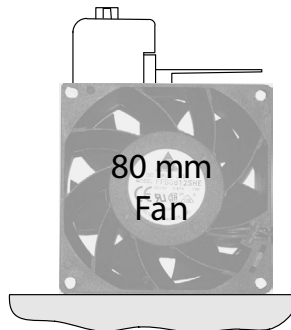

HEATSINK + FAN	°C/W
FORCED-AIR, 300 LFM	0.6

MASTER ORDERING GUIDE

PART NUMBER	DESCRIPTION
ADP-055-18	Accelnet ADP Servo drive, 55 Vdc, 6/18 A
ADP-090-09	Accelnet ADP Servo drive, 90 Vdc 3/9 A
ADP-090-18	Accelnet ADP Servo drive, 90 Vdc, 6/18 A
ADP-090-36	Accelnet ADP Servo drive, 90 Vdc, 12/36 A
ADP-180-09	Accelnet ADP Servo drive, 180 Vdc, 3/9 A
ADP-180-18	Accelnet ADP Servo drive, 180 Vdc, 6/18 A
ADP-180-30	Accelnet ADP Servo drive, 180 Vdc, 15/30 A

Add -S to part numbers above for sin/cos feedback (*ServoTube motors*)
 Add -R to part numbers for resolver feedback

ACCESSORIES

	QTY	DESCRIPTION
Connector Kit ADP-CK	1	Connector, 6 Terminal, 5.08 mm
	1	26 Pin Connector, High Density, D-Sub, Solder Cup
	1	26 Pin Connector Backshell
	1	15 Pin Connector, High Density, D-Sub, Solder Cup
	1	15 Pin Connector Backshell
CANopen Network Kit ADP-NK	1	Adapter Assy, DB9 Female to RJ45 Jack (XTL-CV)
	1	CANopen Network Cable, 10 ft. (XTL-NC-10)
	1	CANopen Network Terminator (XTL-NT)
Heatsink Kit ADP-HK	1	Heatsink, Low Profile
	1	Heatsink Thermal Material
	4	Heatsink Hardware
ADP-CV		Adapter Assembly, DB9 Female to RJ45 Jack
ADP-NC-10		CANopen Network Cable, 10 ft
ADP-NC-01		CANopen network cable, 1 ft
ADP-NT		CANopen Network Terminator
SER-CK		Serial Cable Kit

ORDERING EXAMPLE

Example: Order an ADP-090-18-S servo drive with heatsink installed at factory and associated components:

Qty	Item	Remarks
1	ADP-090-18-S-H	Accelnet servo drive
1	ADP-CK	Connector Kit
1	SER-CK	Serial Cable Kit